



IK Tapered
2026-V2





RESISTA[®]
Since 1946
A Legacy of over 26 Years in Implantology

ReSmile

| Last Generation of surface treatment |
| New Concept of Drill Technology |



RESISTA, trademark owned by **Ing. Carlo Alberto Issoglio & C. S.r.l.**, identifies the full range of products designed by the company to meet the needs of dentists and technicians.

RESISTA is known all over the world since 1946, and synonymous of guarantee, balance, and continuity.

RESISTA GROUP

Resista Group, owned by Carlo Alberto Issoglio & C.S.r.l., has been operating since 1946 and has more than 75 years of experience in the dental industry. Resista Group has different Sub Brands, such as Resista (dental implants), Replica (prosthetic parts), Revolution (digital dentistry), Nobil-Bioresearch (research and development), and Resista Academy is the specialized educational department of the group.



Resista Group has received its UNI EN ISO 9001 and UNI EN ISO 13485 (QS) approvals from the ICIM Institute to implement a precise process system and provide services and the quality control system under the medical equipment guidelines.

with Its **CE-MDR** Certification Resista Complies with the Highest Level of European Regulatory Standards, Ensuring Proven clinical Safety and full Product Traceability.



One of the main production sites of Resista Group is located in Italy and near Switzerland in an area called **Omegna**. And Resista Group has active representation in more than **35 countries of the world**.



Content

RESISTA GROUP	3
DAE surface Technology	6
PRO MSD drill Technology	8
IK (universal)	9
Fixture.....	10
Prosthetics.....	12
Digital Solution.....	15
IK (Narrow & Mini)	17
Fixture.....	18
Prosthetic.....	19
Digital solution.....	20
IK (Wide)	21
Fixture.....	22
Prosthetic.....	23
Surgical Kits	25
Kits.....	27
Instrument	30
Surgical Sequences	31
Bone Management kits	30
Sinus lift.....	30
Implant remover.....	31
Bone expander.....	32
REVO (Digital Souttion)	34
Revo kit.....	34
Revo instrument	34
Bibliography	35
Resista view	36
Resist Academy	37
Resista Codes	39



DAE

Surface

Last Generation of
Surface Treatment

Plasma Modification

Hybrid Roughness



DAE Surface Treatment

In the production of resistant implants from the biomechanical concept, compliance with the golden standard of 7 to 10 micrometers for the connections of prosthetic parts, the use of Gr.4, Gr.5 Titanium ASTM (ISO Standard 5832) as raw materials for implant production and also for covering the surface of fixtures Non-contaminant micro-subtraction process and double acid etching (DAE), roughness change in micro dimensions (Ra, Rq) and surface texture that maximizes wettability and biomimetic ratio. The new process of surface coating and disinfection has been registered by Nobil BioRicerche, which improves the biochemical properties of the implant.

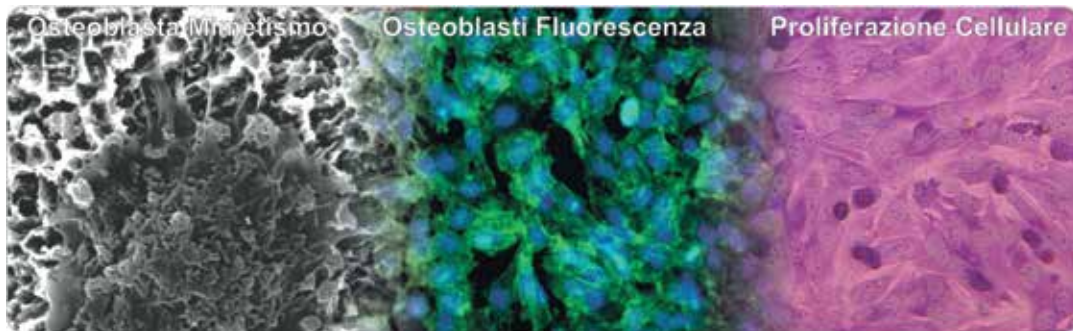

The Micro-Nano Rough DAE surface treatment speeds up bone healing processes

- Removes the manufacturing organic residuals along with Argon Plasma Cleaning
- Smooths the edge and eliminates the micro-defects
- Increases surface and wettability (hydrophilicity surface), improving the first fibrin bridge adhesion
- Increases protein adhesion
- Maximizes cellular adhesion through the Micro- Nano roughness suitable for actin filaments (phyllopods) anchoring
- Changes the Titanium surface chemical characteristics improving the biocompatibility and increasing the cellular proliferation and vitality.

Surface topography and chemistry interact with the cellular differentiation processes

The implant surface uses microtopography as a communication language with the host tissue cells. The Plasma Argon Cold Cleaning with a controlled-environment packaging at strict protocol procedures, plays a key role in the control of adhered endotoxins (main immunological response player to implant surfaces).

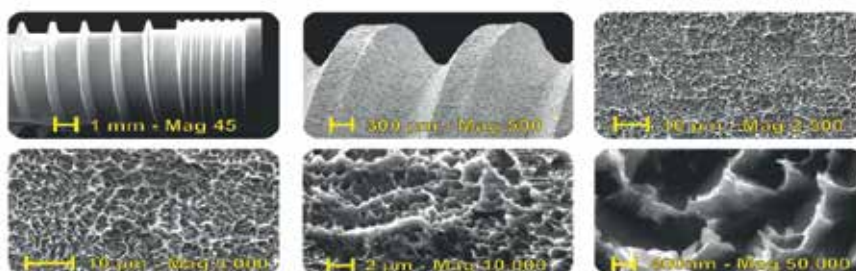

IMPLANT FEATURE

Last Generation Differentiated Surface (Full, Half, and Machined) treated (DAE Micro and Nano rough), decontaminated in Argon Cold Plasma Reactor.



- 1. Machined Surface: Brushed, rectified, and protected during the roughening process
- 2. Nano-rough Surface: Speedy treatment, nano-rough with average Ra less than one micron
- 3. Micro-rough Surface: 3/5 μ : DAE Treatment, micro-rough with average Ra between 3/5 μ
- 4. Micro-rough Surface: 4/7 μ : DAE Slow Treatment, micro-rough with average Ra between 4/7**

PRO MSD technology

Surgical Drills 3-Tech, maximum efficiency, minimum trauma, smaller friction coefficient, PRO MSD technology for counterclockwise bone densifying application, lasting resistance, perfect visibility of laser marking, and surgical millimeters stop



The anticlockwise rotation, reversing the involved forces, generates 3 different effects on the implant tunnel perforation, which can revolutionize the known milling logic.

Anterior and lateral thrust of the bone removed by the tip, and of the liquids as well, blood and physiological water.

- Ejection and "hammer effect" of the drill that produce an improvement in vertical control.
- Reduction of cutting efficiency to protect sensitive anatomical parts.

Resistance, perfect visibility of laser marking, and surgical millimeters stop

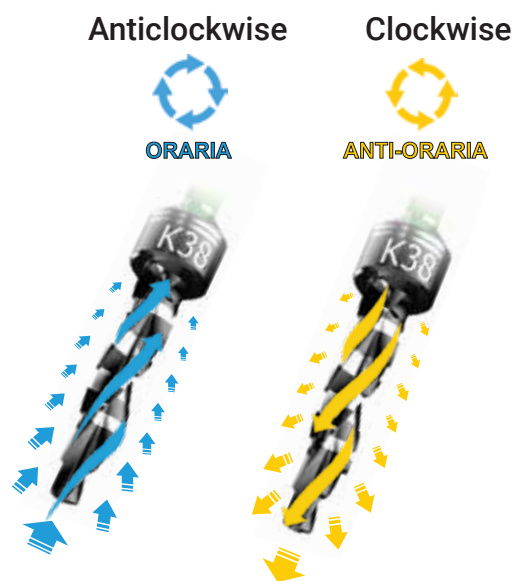



IK

Universal

Fixture

Prosthetic

Digital Solution



Fixture IK (FULL TREATMENT)

- Full treatment of DAE surface technology and internal hexagon connection
- Titanium Gr.4
- 0.5 mm machined polish on the collar of the fixture
- Tapered design by 2 on the body and 6 on the apex
- Screw pitch 0.8 mm -1.00 mm
- For 3.4 φ max torque is 75 Ncm & For 3.8, 4.2 ,4.6 φ max torque is 95 Ncm



IK 34 Platform φ 3.5 CPS

Diameter	3.4 φ	3.4 φ	3.4 φ	3.4 φ	3.4 φ	3.4 φ
Height	7 mm	8.5 mm	10 mm	11.5 mm	13 mm	15 mm
Apex	1.7 φ	1.7 φ	1.7 φ	1.7 φ	1.7 φ	1.7 φ
Code	IK 3407	IK 3408	IK 3410	IK 3411	IK 3413	IK 3415



IK 38 Platform φ 4.0

Diameter	3.8 φ	3.8 φ	3.8 φ	3.8 φ	3.8 φ	3.8 φ
Height	7 mm	8.5 mm	10 mm	11.5 mm	13 mm	15 mm
Apex	1.8 φ	1.8 φ	1.8 φ	1.8 φ	1.8 φ	1.8 φ
Code	IK 3807	IK 3808	IK 3810	IK 3811	IK 3813	IK 3815

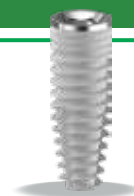

IK 42 Platform φ 4.0

Diameter	4.2 φ	4.2 φ	4.2 φ	4.2 φ	4.2 φ	4.2 φ
Height	7 mm	8.5 mm	10 mm	11.5 mm	13 mm	15 mm
Apex	2.2 φ	2.2 φ	2.2 φ	2.2 φ	2.2 φ	2.2 φ
Code	IK 4207	IK 4208	IK 4210	IK 4211	IK 4213	IK 4215



IK 46 Platform φ 4.0

Diameter	4.6 φ	4.6 φ	4.6 φ	4.6 φ	4.6 φ	4.6 φ
Height	7 mm	8.5 mm	10 mm	11.5 mm	13 mm	15 mm
Apex	2.6 φ	2.6 φ	2.6 φ	2.6 φ	2.6 φ	2.6 φ
Code	IK 4607	IK 4608	IK 4610	IK 4611	IK 4613	IK 4615



Fixture IK (HALF TREATMENT)

- HALF treatment of DAE surface technology and internal hexagon connection
- Titanium Qr.4
- 3.5 mm machined polish and anodized with TiO2 on the collar of the fixture
- Tapered design by 2 on the body and 6 on the apex
- Screw pitch 0.7 mm - 1.00 mm
- For 3.4 φ max torque is 75 Ncm & For 3.8, 4.2, 4.6 φ max torque is 95 Ncm



IK 34 Platform φ 3.5 CPS

Diameter	3.4 φ	3.4 φ	3.4 φ	3.4 φ	3.4 φ
Height	8.5 mm	10 mm	11.5 mm	13 mm	15 mm
Apex	1.7 φ	1.7 φ	1.7 φ	1.7 φ	1.7 φ
Code	IK 3408 HT	IK 3410 HT	IK 3411 HT	IK 3413 HT	IK 3415 HT



IK 38 Platform φ 4.0

Diameter	3.8 φ	3.8 φ	3.8 φ	3.8 φ	3.8 φ
Height	8.5 mm	10 mm	11.5 mm	13 mm	15 mm
Apex	1.8 φ	1.8 φ	1.8 φ	1.8 φ	1.8 φ
Code	IK 3808 HT	IK 3810 HT	IK 3811 HT	IK 3813 HT	IK 3815 HT



IK 42 Platform φ 4.0

Diameter	4.2 φ	4.2 φ	4.2 φ	4.2 φ	4.2 φ
Height	8.5 mm	10 mm	11.5 mm	13 mm	15 mm
Apex	2.2 φ	2.2 φ	2.2 φ	2.2 φ	2.2 φ
Code	IK 4208 HT	IK 4210 HT	IK 4211 HT	IK 4213 HT	IK 4215 HT

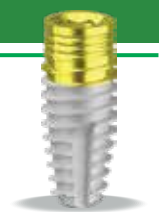

IK 46 Platform φ 4.0

Diameter	4.6 φ	4.6 φ	4.6 φ	4.6 φ	4.6 φ
Height	8.5 mm	10 mm	11.5 mm	13 mm	15 mm
Apex	2.6 φ	2.6 φ	2.6 φ	2.6 φ	2.6 φ
Code	IK 4608 HT	IK 4610 HT	IK 4611 HT	IK 4613 HT	IK 4615 HT



Universal Prosthetics

Healing Abutment

Type	CPS Standard gingival profile			Standard gingival profile		
	Diameter	4 φ	4 φ	4 φ	4 φ	4 φ
Height	2 mm	4 mm	6 mm	2 mm	4 mm	6 mm
Material	titanium Gr 5 -Anodized	titanium Gr 5 -Anodized	titanium Gr 5 -Anodized	titanium Gr 5 -Anodized	titanium Gr 5 -Anodized	titanium Gr 5 -Anodized
Code	IP 4HA2-W	IP 4HA4-W	IP 4HA6-W	IP 4HA2	IP 4HA4	IP 4HA6



Driver : 1.27 φ DM 1/2
Torque : 20Ncm

Straight Abutment

Type	CPS standard gingival profile	CPS standard gingival profile (vertical preparation technique)	Standard gingival Profile	CPS friction fit		ftf friction fit
	Diameter	4 φ	4 φ	4 φ	4 φ	4 φ
Height	2 mm		2 mm	2 mm	3 mm	2 mm
Material	titanium Gr 5 -PVD TiN	titanium Gr 5	titanium Gr 5 + Zirconia	titanium Gr 5 -PVD TiN	titanium Gr 5	titanium Gr 5 + Zirconia
Code	IP 4ST2-W	IP 4STV-W	IP 4SZ	IP 4ST2-WF	IP 4ST3-WF	IP 5ST2-F



Driver : 1.27 φ DM 1/2
Torque : 20Ncm

Temporary Abutment

Type	CPS Standard gingival profile			Standard gingival profile	
	Technic	glueing	glueing	Welding	Aesthetic
Diameter	4 φ	4 φ	4 φ	4 φ	
Hex	Anitrotation Hex	Rotating	Rotating	Anitrotation Hex	
Material	titanium Gr 5	titanium Gr 5	titanium Gr 5	Medical PEEK	
Code	IP 4TA-W	IP 4TR-W	IP 4TR-S	IP 4TA-W	

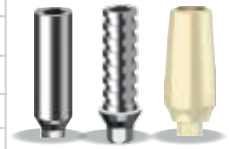

Driver : 1.27 φ DM 1/2
Torque : 20Ncm

Angled Abutment

Type	CPS standard gingival profile	Standard gingival profile (aesthetic)	CPS friction fit		ftf friction fit
	Diameter	4 φ	4 φ	4 φ	4 φ
Height			2 mm	2 mm	2 mm
Material	titanium Gr 5 -PVD TiN	titanium Gr 5 + Zirconia		titanium Gr 5 -PVD TiN	titanium Gr 5 -PVD TiN
Code	IP 4AT15-W	IP 4AZ15	IP 4AT152-WF	IP 4ST2-WF	IP 5ST152-F



Driver : 1.27 φ DM 1/2
Torque : 32 Ncm

Type	CPS standard gingival profile	CPS friction fit		ftf friction fit
	Diameter	4 φ	4 φ	4 φ
Height		2 mm	3 mm	2 mm
Material	titanium Gr 5 -PVD TiN	titanium Gr 5 -PVD TiN	titanium Gr 5 -PVD TiN	titanium Gr 5 -PVD TiN
Code	IP 4AT25-W	IP 4AT252-WF	IP 4AT253-WF	IP 5ST252-F



Driver : 1.27 φ DM 1/2
Torque : 32 Ncm

UCLA Abutment

Type	CPS standard gingival profile	
Diameter	4 φ	4 φ
material	CoCr	CoCr
Hex	Antirotating	Rotating
Code	IP 4CCA-W	IP 4CCR-W



Driver : 1.27 φ DM 1/2
Torque : 32 Ncm

Universal Prosthetics

Castable Abutment

Type	CPS standard gingival profile		Standard gingival profile	
	4 φ	4 φ	4 φ	4 φ
Diameter	4 φ	4 φ	4 φ	4 φ
material	acrylic	acrylic	acrylic	acrylic
Hex	Antirotating	Rotating	Antirotating	Rotating
Code	IP 4CA-W	IP 4CR-W	IP 4CA	IP 4CR



Driver : 1.27 φ DM 1/2
Torque : 10 Ncm

Ball Overdenture Abutment

Type	CPS standard gingival profile				
Diameter	4 φ	4 φ	4 φ	4 φ	4 φ
material	titanium Gr 5 -PVD TiN	titanium Gr 5 -PVD TiN	titanium Gr 5 -PVD TiN	titanium Gr 5 -PVD TiN	titanium Gr 5 -PVD TiN
Height	1	2	3	4	6
Code	IP 4BA1-W	IP 4BA2-W	IP 4BA3-W	IP 4BA4-W	IP 4BA6-W



Driver : DM
Torque : 32 Ncm

Equator Overdenture Abutment

Type	Narrow gingival profile				
Diameter	4 φ	4 φ	4 φ	4 φ	4 φ
Material	titanium Gr 5 -PVD TiN	titanium Gr 5 -PVD TiN	titanium Gr 5 -PVD TiN	titanium Gr 5 -PVD TiN	titanium Gr 5 -PVD TiN
Height	1	2	3	4	5
Code	IP 4EQ1	IP4EQ2	IP 4EQ3	IP4EQ4	IP 4EQ5



Driver : DMEQ
Torque : 32 Ncm

Ti-Base Abutment

Type	Link in Titanium Antirotating Bonding Technique		Link in titanium Antirotating CPS Bonding Technique
Diameter	4 φ	4 φ	4 φ
Material	titanium Gr 5	titanium Gr 5	titanium Gr 5
Code	IP 4STB	IP 4SZB	IP 4STB-W



Driver : 1.27 φ DM 1/2
Torque : 10 Ncm

Analog

Type	universal shape	 <p>Driver : 1.27 φ DM 1/2 Torque : 10 Ncm</p>
Diameter	4 φ	
Material	titanium Gr 5 -anodized	
Code	IP 4AL	

Impression

Type	internal hexagon CPS open	 <p>Driver : 1.27 φ DM 1/2 Torque : 10 Ncm</p>
Diameter	4 φ	
Material	titanium Gr 5	
Code	IP X40-W	

Impression

Type	Implant Mounter Imperssion Close	 <p>Driver : 1.27 φ DM 1/2 Torque : 10 Ncm</p>
Diameter	4 φ	
Material	titanium Gr 5	
Code	IP M40	

Toronto Universal Prosthetics

Straight Toronto Abutment

Type	CPS standard gingival profile			 <p>Driver : DCDM Torque : 32 Ncm</p>
Diameter	4 φ	4 φ	4 φ	
Height	1 mm	2 mm	3 mm	
Material	titanium Gr 5	titanium Gr 5	titanium Gr 5	
Code	IP MS1-W	IP MS2-W	IP MS3-W	

Angel Toronto Abutment

Type	CPS standard gingival profile					 <p>Driver : DMX 1/2 Torque : 32 Ncm</p>
Diameter	4 φ	4 φ	4 φ	4 φ	5 φ	
Height	2 mm	3 mm	3 mm	4 mm	5 mm	
Material	17	17	30	30	30	
Code	IP MA172-W	IP MA173-W	IP MA303-W	IP MA304-W	IP MA305-W	

Temporary Toronto Abutment

Type	CPS standard gingival profile		 <p>Driver : DMX 1/2 Torque : 10 Ncm</p>
Technique	Bonding	welding	
Diameter	4 φ	4 φ	
Material	titanium Gr 5	titanium Gr 5	
Hex	Rotating	Rotating	
Code	EP MT	EP MT-S	

Healing Toronto Abutment

Type	Standard gingival profile		 <p>Driver : DMX 1/2 Torque : 15 Ncm</p>
Diameter	4 φ	4 φ	
Material	4 mm	6 mm	
Hex	PE	PE	
Code	IP 4HA2-W	IP 4HA4-W	

Impression Toronto

Type	Standard gingival profile	 <p>Driver : DMX 1/2 Torque : 15 Ncm</p>
Diameter	4 φ	
Material	titanium Gr 5	
Code	EP MI	



Analog Toronto

Type	Universal shape	 <p>Driver : DMX 1/2 Torque : 15 Ncm</p>
Diameter	4 φ	
Material	titanium Gr 5	
Code	EP MI	

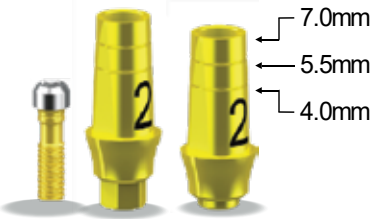

Castable Toronto Abutment

Type	Standard gingival profile	 <p>Driver : DMX 1/2 Torque : 15 Ncm</p>
Diameter	4 φ	
Material	acrylic	
Hex	Rotating	
Code	EP MC	

Digital Universal Prosthetics

Type	Digital Solutions				
Component	Scan abutment	Ti-Base		Laboratory analog	
Diameter	4 φ	4 φ	4 φ	4 φ	5 φ
Hex	Antirotating	Anitrotation	Rotating		
Material	titanium Gr 5-micro sandblasting	titanium Gr 5	titanium Gr 5	titanium Gr 5	titanium Gr 5
Code	IP 4SA DS	IP 4TB DS	IP 4TBR DS	IP 4AL DS	IP 5AL DS
					

Toronto Digital Universal Prosthetics

Type	Digital Solutions		
Component	Scan Abutment	Ti-Base	Laboratory analog
Diameter	4 φ	4 φ	4 φ
Hex	Rotating	Rotating	
Material	titanium Gr 5	titanium Gr 5	titanium Gr 5
Code	EP MSA DS	EP MT DS	EP MAL DS
			



IK

Digital Solutions

Digital Universal Prosthetics

Toronto Digital Universal Prosthetics



IK

Narrow | Mini

Fixture

Prosthetic

Digital Solution

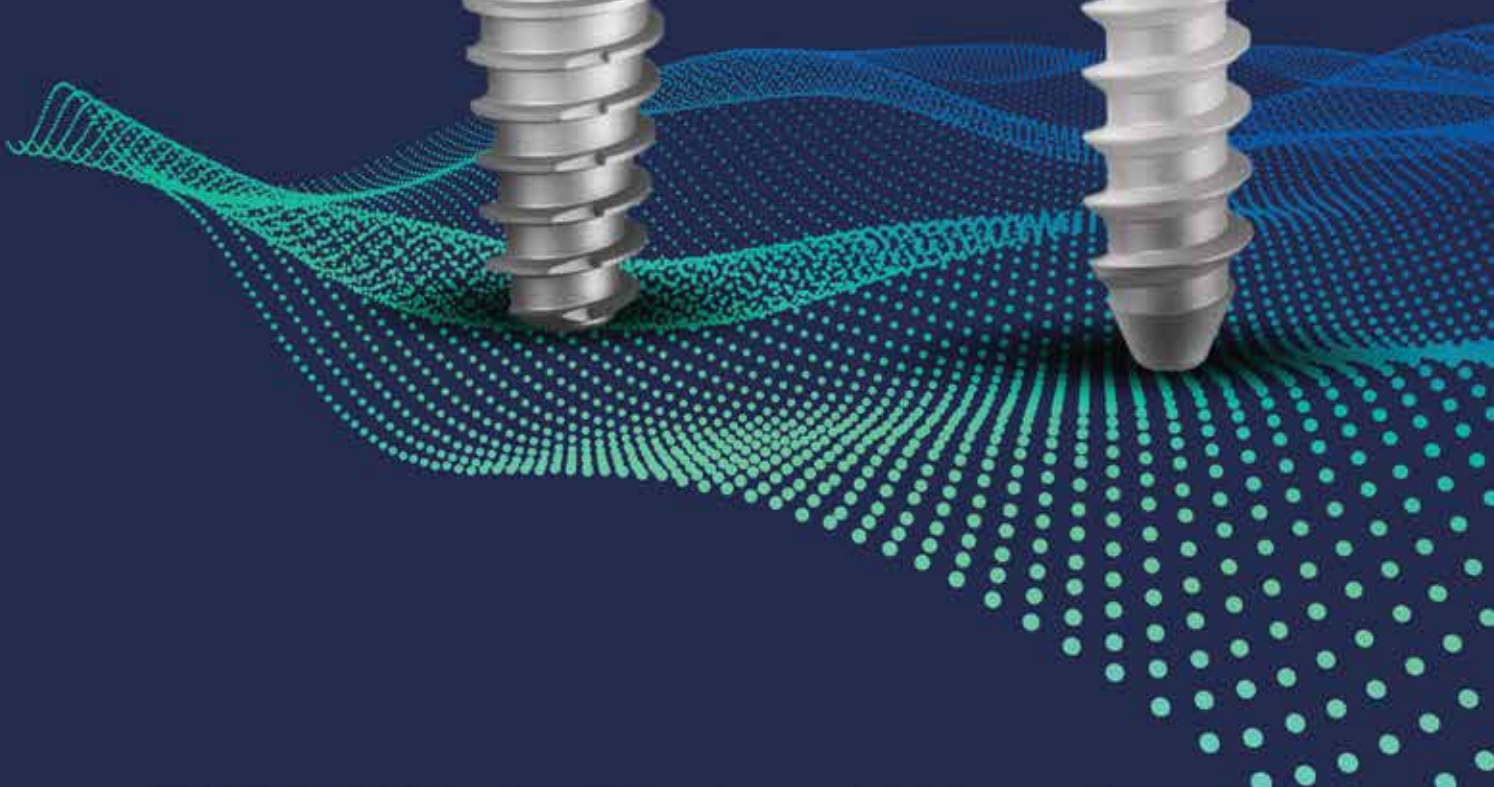

IK Fixture (Narrow & Mini)

- DAE surface & 2.00 mm Machine anodizing on the collar of the k-narrow implant
- DAE surface & 2.5 mm neck and 1.8 mm hexagon on ball type of mini-implant 0.8 m m in k-narrow & 1.2 in mini-implant Screw pitch
- Taper ed design by 2 on the body and 6 in the apex for k-narrow implant
- For 2.9 ϕ max torque is 40 Ncm & For 2.7 ϕ max torque is 75 Ncm



KN 29 Neck ϕ 3.0

Diameter	2.9 ϕ	2.9 ϕ	2.9 ϕ	2.9 ϕ
Length	8.5 mm	10 mm	11.5 mm	13 mm
Apex	1.5 ϕ	1.5 ϕ	1.5 ϕ	1.5 ϕ
Code	IK 2908	IK 2910	IK 2911	IK 2913

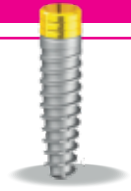

MS 27 One Piece

Diameter	2.9 ϕ	2.9 ϕ	2.9 ϕ	
Length	10 mm	11.5 mm	13 mm	
Apex	micro	micro	micro	
Code	MSM 2710	MSM2711	MSM 2713	



Diameter	2.9 ϕ	2.9 ϕ	2.9 ϕ	
Length	10 mm	11.5 mm	13 mm	
Apex	normal	normal	normal	
Code	MS 2710	MS 2711	MS 2713	



MM 27 One piece

Diameter	2.9 ϕ	2.9 ϕ	2.9 ϕ	
Length	10 mm	11.5 mm	13 mm	
Apex	abutment	abutment	abutment	
Code	MM 2710	MM2711	MM 2713	

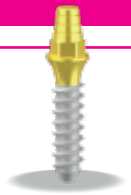

K-Narrow Prosthetics

Healing Abutment

Type	Narrow Gingival Profile			
Diameter	2 φ	2 φ	2 φ	2 φ
Height	2 mm	3 mm	5 mm	7 mm
Material	Titanium Gr 5	Titanium Gr 5	Titanium Gr 5	Titanium Gr 5
Code	IP 2HA2	IP 2HA4	IP 2HA6	IP 2HA2



Driver : DMX 1.20 DMRP120S
Torque : 25 Ncm

Straight abutment

Type	Narrow Gingival Profile			
Diameter	2 φ	2 φ	2 φ	
Height	2 mm	3 mm	5 mm	
Material	titanium Gr 5	titanium Gr 5	titanium Gr 5	
Code	IP 2ST2	IP 2ST3	IP 2ST5	



Driver : DMX 1.20 DMRP120S
Torque : 25 Ncm

Angel abutment

Type	Narrow Gingival Profile			
Diameter	2 φ	2 φ	2 φ	2 φ
Height	2 mm	3 mm	2 mm	3 mm
Angel	15	15	25	25
Material	titanium Gr 5	titanium Gr 5	titanium Gr 5	titanium Gr 5
Code	IP 4AT15-W	IP 4AZ15	IP 4AT152-WF	IP 4AT153-WF



Driver : DMX 1.20 DMRP120S
Torque : 25 Ncm

UCLA abutment

Type	Narrow Gingival Profile			
Diameter	2 φ	2 φ		
Height	CoCr	CoCr		
Material	Antirotating	Rotating		
Code	IP 2CCA	IP 2CCR		



Driver : DMX 1.20 DMRP120S
Torque : 25 Ncm

Equator abutment

Type	Narrow Gingival Profile				
Diameter	2 φ	2 φ	2 φ	2 φ	2 φ
Material	titanium Gr 5 -PVD TiN	titanium Gr 5 -PVD TiN	titanium Gr 5 -PVD TiN	titanium Gr 5 -PVD TiN	titanium Gr 5 -PVD TiN
Height	1	2	3	4	5
Code	IP 2EQ1	IP 2EQ2	IP 2EQ3	IP 2EQ4	IP 2EQ5



Driver : DMEQ
Torque : 25 Ncm

Analog

Type	narrow gingival profile
Diameter	2 φ
Material	titanium Gr 5
Code	IP 2IA









Impression Analog

Type	narrow gingival profile
Diameter	2 φ
Material	titanium Gr 5
Code	IP 2AL

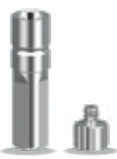

Driver : DMX 1.20 DMRP120S
Torque : 25 Ncm

Digital K-Narrow Prosthetics

Type	Digital Solution							
Component	Scan abutment	Analog	Ti-Base					
Diameter	2 φ	analog	2 φ	2 φ	2 φ	2 φ	2 φ	2 φ
Hex		2 φ	Anitrotation	Rotating	Anitrotation	Rotating	Anitrotation	Anitrotation
Height			1	1	2	2	3	3
Material	titanium Gr 5-PVD TiN	titanium Gr 5	titanium Gr 5	titanium Gr 5	titanium Gr 5	titanium Gr 5	titanium Gr 5	titanium Gr 5
Code	IP 2SA DS	IP 2AL DS	IP 2TB1 DS	IP 2TBR1 DS	IP 2TB2 DS	IP 2TBR2 DS	IP 2TB3 DS	IP 2TBR3 DS
Pic.								

Download CAD/CAM Libraries:

<https://resista.noyandental.com/cadcam-libraries/>





IK

Wide

Fixture

Prosthetic

Digital Solution



IK Fixture (Wide)

- HALF treatment of DAE surface technology and internal hexagon connection
- 3.5 mm machined polish and anodized with TiO₂ on the collar of the fixture
- Tapered design by 2 on the body and 6 on the apex
- Screw pitch 0.7 mm - 1.00 mm
- For 5.0 ϕ max torque is 95 Ncm & For 6.0 , 8.0 ϕ max torque is 95 Ncm



IK 50 Platform ϕ 5.0

Diameter	5.0 ϕ	5.0 ϕ	5.0 ϕ	5.0 ϕ	5.0 ϕ	5.0 ϕ
Length	7 mm	8.5 mm	10 mm	11.5 mm	13 mm	15 mm
Apex	3.3 ϕ	3.3 ϕ	3.3 ϕ	3.3 ϕ	3.3 ϕ	3.3 ϕ
Code	IK 5007	IK 5008	IK 5010	IK 5011	IK 5013	IK 5015



IK 50 HT Platform ϕ 5.0

Diameter	5.0 ϕ	5.0 ϕ	5.0 ϕ	5.0 ϕ	5.0 ϕ
Length	8.5 mm	10 mm	11.5 mm	13 mm	15 mm
Apex	3.3 ϕ	3.3 ϕ	3.3 ϕ	3.3 ϕ	3.3 ϕ
Code	IK 5008 HT	IK 5010 HT	IK 5011 HT	IK 5013 HT	IK 5015 HT



IK 60 Platform ϕ 5.0

Diameter	6.0 ϕ	6.0 ϕ	6.0 ϕ
Length	7 mm	8.5 mm	10 mm
Apex	4.5 ϕ	4.5 ϕ	4.5 ϕ
Code	IK 6007	IK 6008	IK 6010



IK 80 Platform ϕ 5.0

Diameter	8.0 ϕ	8.0 ϕ	8.0 ϕ
Length	7 mm	8.5 mm	10 mm
Apex	6.0 ϕ	6.0 ϕ	6.0 ϕ
Code	IK 8007	IK 8008	IK 8010



Wide Prosthetics

Healing abutment

Type	large gingival profile	
Diameter	5 φ	5 φ
Material	titanium Gr 5 -anodized	titanium Gr 5 -anodized
Code	IP 5HA3	IP 5HA5



Driver : DM 1/2
Torque : 32 Ncm

Straight abutment

Type	large gingival profile	
Diameter	5 φ	5 φ
Material	titanium Gr 5 -PVD TiN	titanium Gr 5-zirconia
Code	IP 5ST3	IP 5SZ



Driver : DM 1/2
Torque : 32 Ncm

Angel abutment

Type	large gingival profile		
Diameter	5 φ	5 φ	5 φ
Height	titanium Gr 5 -PVD TiN	titanium Gr 5 -PVD TiN	titanium Gr 5-zirconia
Angel	15	25	15
Code	IP 5AT15	IP 5AT25	IP 5AZ15



Driver : DM 1/2
Torque : 32 Ncm

Castable abutment

Type	large gingival profile	
Diameter	5 φ	5 φ
Height	acrylic	acrylic
Angel	Antirotating	Rotating
Code	IP 5CA	IP 5CR



Temporary abutment

Type	Waisted CPS gingival profile			large gingival profile
Diameter	4 φ	4 φ	4 φ	5 φ
Hex	Antirotating	Rotating	Rotating	Antirotating
Technique	glueing	glueing	welding	aesthetic
Material	titanium Gr 5	titanium Gr 5	titanium Gr 5	medical peek
Code	IP 4TA-W	IP 4TR-W	IP 4TR-S	IP 5PA

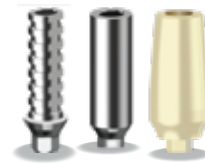

Driver : DM 1/2
Torque : 32 Ncm

UCLA abutment

Type	standard gingival profile		Waisted CPS gingival profile	large gingival profile	
Diameter	4 φ	4 φ	4 φ	4 φ	5 φ
Material	CoCr	CoCr	CoCr	CoCr	GOLD
Hex	Antirotating	Rotating	Antirotating	Rotating	Antirotating
Code	IP 4CCA	IP 4CCR	IP 4CCA-W	IP 4CCR-W	IP 5GA



Driver : DM 1/2
Torque : 32 Ncm

Wide Prosthetics

Equator abutment

Type	narrow gingival profile					 Driver: DM 1/2 Torque: :32 Ncm
Diameter	4 φ	4 φ	4 φ	4 φ	4 φ	
Material	titanium Gr 5 -PVD TiN	titanium Gr 5 -PVD TiN	titanium Gr 5 -PVD TiN	titanium Gr 5 -PVD TiN	titanium Gr 5 -PVD TiN	
Height	1	2	3	4	5	
Code	IP 4EQ1	IP4EQ2	IP 4EQ3	IP4EQ4	IP 4EQ5	

Ball abutment

Type	CPS standard gingival profile					 Driver: DM 1/2 Torque: :32 Ncm
Diameter	4 φ	4 φ	4 φ	4 φ	4 φ	
material	titanium Gr 5 -PVD TiN	titanium Gr 5 -PVD TiN	titanium Gr 5 -PVD TiN	titanium Gr 5 -PVD TiN	titanium Gr 5 -PVD TiN	
height	1	2	3	4	5	
Code	IP 4BA1-W	IP 4BA2-W	IP 4BA3-W	IP 4BA4-W	IP 4BA6-W	

Analog

Type	universal shape	
Diameter	5 φ	
Material	titanium Gr 5 -anodized	
Code	IP 5AL	

Impression

Type	internal hexagon	 Driver: DMX 1.20 Torque: :25 Ncm
Diameter	5 φ	
Material	titanium Gr 5	
Code	IP X50	



SURGICAL KIT



- Implant Surgical Kits
- Bone management Kits
- Digital solution Kits
- Instrument
- Drilling Sequence



KIT001-single line kit

- MK (single line conical), MC (single line cylindrical)
- PK (single line conical - platinum connection), PC (single line cylindrical - platinum connection)
- The accessories of this kit include: box, drills, drill stopper, fixture drivers, prosthetics drivers, ratchet
- Use PRO SD technology for drills
- 001MK is suitable for IK line surgery



KIT002-standard kit

- 002 (standard surgery kit), 002P (standard surgery kit- platinum connection)
- The accessories of this kit include: box, KS & CS drills, drill stopper, fixture drivers, prosthetics drivers, ratchet
- Use PRO SD technology for drills
- 002KIT is suitable for IK-IC-IA lines surgery



KIT FCK-Calibrated kit

- FCK KIT has a self-stopper drill which helps with speedy surgery
- The accessories of this kit include: box, drills, fixture drivers, prosthetics drivers, ratchet
- Use PRO SD technology for drills



K-NARROW KIT

- Suitable for IK TAPPER K-NARROW fixture drilling
- Use PRO SD technology for drills



RPS/L KIT – Prosthetic driver

- RPS/L KIT are available in 4 types.
- RPS01 (5 short drivers), RPS02 (5 short drivers + 1 dynamo ratchet),
- RPL01 (5 long drivers), RPL02 (5 long drivers + 1 dynamo atchet),
- REPLICA KIT with the name of RPS/L are specific for prosthetic products



KIT001-single line kit

This surgical kit includes one drill line.
 All parts needed for surgery are in this kit
 This kit is user friendly It does not confuse doctors.

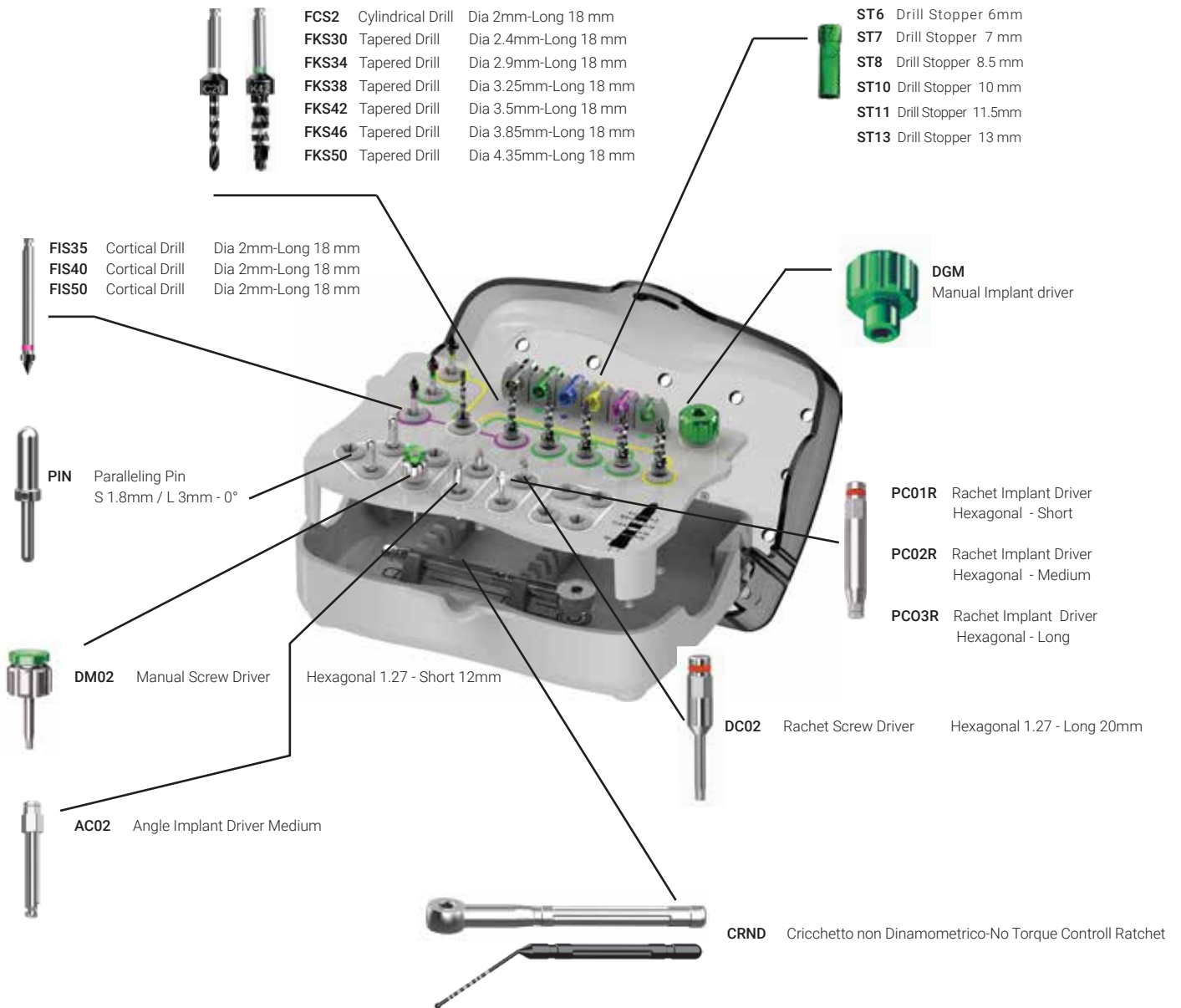

- MK (single line Conical). MC (single Line Cylindrical)
- PK (Single Line Conical - Platinum Connection), PC (Single Line Cylindrical - Platinum Connection)
- The accessories of this kit include: Box, Drills, Drill Stopper, fixture Drivers, Prosthetics Drivers, Ratchet
- Use PRO SD Technology for drills
- 001 MK is suitable for IK line Surgery

Drills

Cortical Drills

FIS30	Ø 3.0mm	
FIS35	Ø 3.5mm	
FIS40	Ø 4.0mm	
FIS50	Ø 5.0mm	

Cylindrical Drills













FCS20	Ø 2.0 mm-Long 18 mm	
FCS30	Ø 2.6 mm-Long 18 mm	
FCS34	Ø 2.9 mm-Long 18 mm	
FCS38	Ø 3.2 mm-Long 18 mm	
FCS42	Ø 3.6 mm-Long 18 mm	
FCS46	Ø 3.9 mm-Long 18 mm	
FCS50	Ø 4.4 mm-Long 18 mm	
FCS55	Ø 4.7 mm-Long 18 mm	

Tapered Drills











FKS30	Ø 2.4 mm-Long 18 mm	
FKS34	Ø 2.9 mm-Long 18 mm	
FKS38	Ø 3.2 mm-Long 18 mm	
FKS42	Ø 3.5 mm-Long 18 mm	
FKS46	Ø 3.8 mm-Long 18 mm	
FKS50	Ø 4.3 mm-Long 18 mm	
FKS60	Ø 5.0 mm-Long 15 mm	
FKS80	Ø 7.0 mm-Long 15 mm	

Screw Driver

Manual Screw Drivers

DM 01	Hexagonal 1.27 - Short - 12mm		
DM 02	Hexagonal 1.27 - Medium - 17mm		
DM 03	Hexagonal 1.27 - Long - 27mm		
DMX 01	Torx - Short - 15mm		
DMX 02	Torx - Long - 20mm		
DMRP120S	Hexagonal 1.20 - Short		
DMRP120L	Hexagonal 1.20 - Long		
DM T6DS	T6 Angled Torx Driver - 15mm		
Equator DMEQ	Squared - Short - 15mm		
EKN	Abutment Extractor		

ANGLE SCREW DRIVERS









DC 01	Hexagonal 1.27 - Short - 15mm		
DC 02	Hexagonal 1.27 - Medium - 20mm		
DC 03	Hexagonal 1.27 - Long - 30mm		
ACDRCA	Hexagonal 1.20		
DC T6DS	T6 Angled Torx Driver - 20mm		
DCEQ	Equator Squared - Medium - 20mm		
DCX 01	Torx - Short - 15mm		
DCX 02	Torx - Long - 20mm		

Ratchet Control Driver

DCD 01	Hexagonal 1.27 - Short - 15mm		
DCD 02	Hexagonal 1.27 - Medium - 20mm		
DCD 03	Hexagonal 1.27 - Long - 30mm		
DCDX 01	Torx - Short - 15mm		
DCDX 02	Torx - Long - 20mm		
DCDM	Hexagonal - Monconi Toronto Diritti		

Implant Driver

ANGLE IMPLANT DRIVERS

AC 01	Angle	Hexagonal - Short		
AC 02	Angle	Hexagonal - Medium		
ACK 2S	Angle	Hexagonal - Short		
ACK 2L	Angle	Hexagonal - Medium		
PCK 2S	Torgue	Hexagonal - Short		
PCK 2L	Torgue	Hexagonal - Long		
PC 01R	Torgue	Hexagonal - Short		
PC 02R	Torgue	Hexagonal - Medium		
PC 03R	Torgue	Hexagonal - Long		

Mini Implant Driver

PCM	Cricchetto - Ratchet		
ACM	Contrangolo - Contriangle		

Drill Extention

PR PC	
-------	---

Finger Driver

DGM	
-----	---

RACHET & GAGE

CRND	No Torque	Ratchet	
CR2	Torque	Ratchet	
CRDP2	Torque	Ratchet	
SOM	Titanium Surgical Probe	Gaga	

IK Drilling Sequence

KN 29

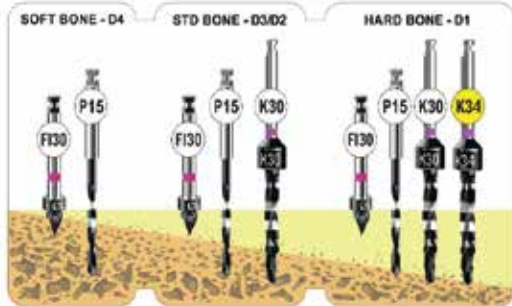

IK 34

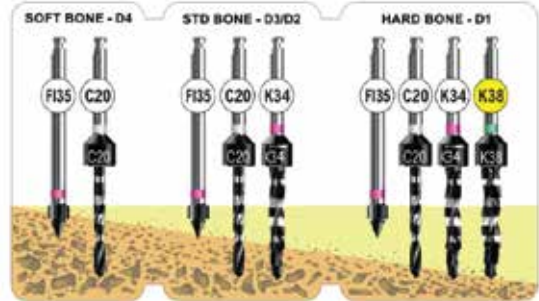

IK 38

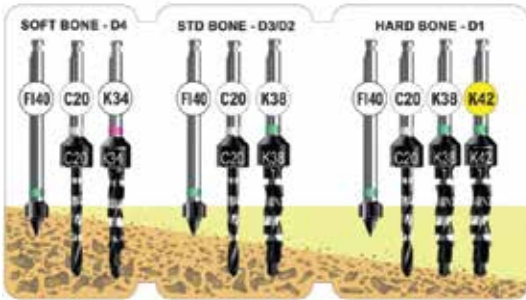

IK 42

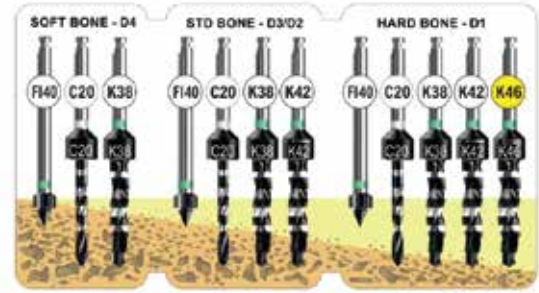

IK 46

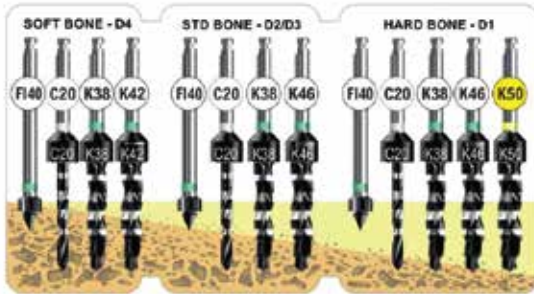

IK 50

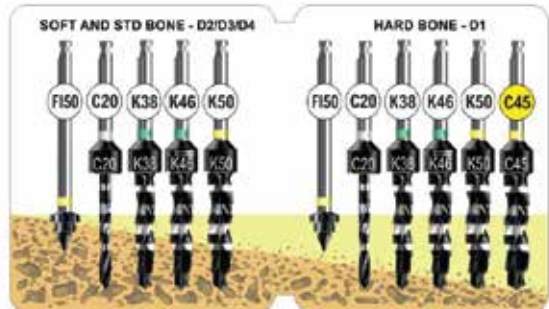

IK 60

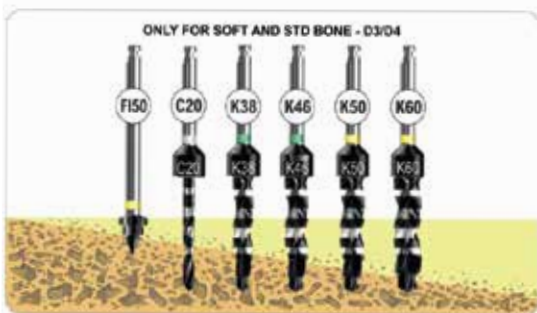

IK 80

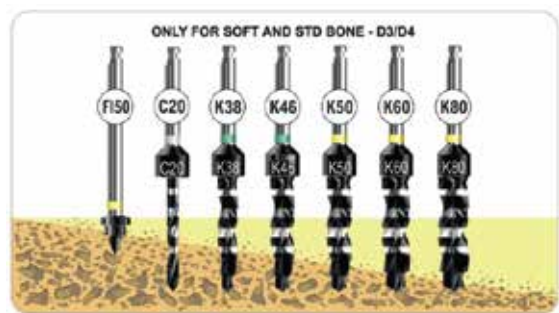

UNIVERSAL IMPLANT EXTRACTOR

**FRACTURED
IMPLANTS**

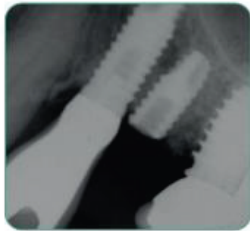

**IMPLANT
REPLACED**

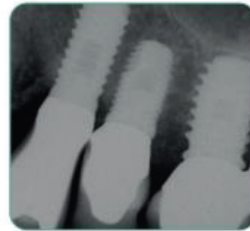

**IMPLANT REMOVAL WITH
ANTI-CLOCK WISE SCREWING**

**IMMEDIATE REPLACEMENT
WITH A NEW IMPLANT**

DLC-Coating
Hardness and less friction

3-Start thread
120Ncm

Progressive taper
Incremental

Extra-hard Steel
68 Rockwell



EXT Implant Extractor - 1 pcs.

KIT 007 Implant Extractor Kit - 2 Extractors + 1 Box + CRND

Bone Expanders and Compactors - Titanium Gr. 5



EXP 4 Progressive diameters
KIT 005 Expander Surgical Kit

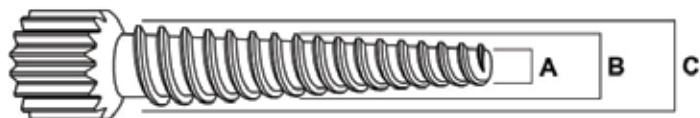

A 1.3	A 1.6	A 1.9	A 2.4
B 2.1	B 2.8	B 3.5	B 4.3
C 2.4	C 3.1	C 3.8	C 4.6

REVOLUTION KIT

Smart KIT is provided for digital solution



FG - SPECIAL DRILLS

- FG P15 Pins Drill - Ø 1.5 mm
- FG B55 L Bone Mill Drill - Ø 5.5 mm - ● Large

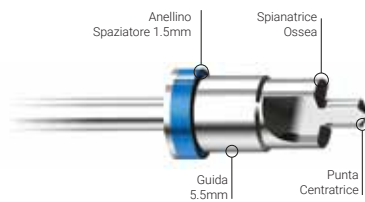

FG M - MUCOTOMES

- FGR M41 S Mucotome Drill - Ø 4.1 mm ● Small
- FGR M45 L Mucotome Drill - Ø 4.5 mm ● Large
- FGR M55 L Mucotome Drill - Ø 5.3 mm ● Large



FG C - CORTICAL DRILLS



- FGR C35 S Corticall Dril - Ø 3.5 mm ● Small
- FGR C40 S Corticall Dril - Ø 4.0 mm ● Small
- FGR C35 L Corticall Dril - Ø 3.5 mm ● Large
- FGR C40 L Corticall Dril - Ø 4.0 mm ● Large
- FGR C50 L Corticall Dril - Ø 5.0 mm ● Large

Revo Drill

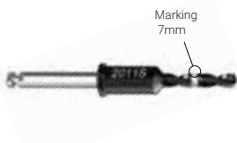

- FGR 2008 S** First Drill - Ø 2.0 mm - Long 8,5 mm
- FGR 2010 S** First Drill - Ø 2.0 mm - Long 10 mm
- FGR 2011 S** First Drill - Ø 2.0 mm - Long 11,5 mm
- FGR 2013 S** First Drill - Ø 2.0 mm - Long 13 mm
- FGR 2015 S** First Drill - Ø 2.0 mm - Long 15 mm



- FGR 4608 L** 4.6 Implant Drill - Ø 3.9 mm - Long 8,5 mm
- FGR 4610 L** 4.6 Implant Drill - Ø 3.9 mm - Long 10 mm
- FGR 4611 L** 4.6 Implant Drill - Ø 3.9 mm - Long 11,5 mm
- FGR 4613 L** 4.6 Implant Drill - Ø 3.9 mm - Long 13 mm
- FGR 4615 L** 4.6 Implant Drill - Ø 3.9 mm - Long 15 mm



- FGR 2008 L** First Drill - Ø 2.0 mm - Long 8,5 mm
- FGR 2010 L** First Drill - Ø 2.0 mm - Long 10 mm
- FGR 2011 L** First Drill - Ø 2.0 mm - Long 11,5 mm
- FGR 2013 L** First Drill - Ø 2.0 mm - Long 13 mm
- FGR 2015 L** First Drill - Ø 2.0 mm - Long 15 mm



- FGR 5008 L** 5.0 Implant Drill - Ø 4.3 mm - Long 8,5 mm
- FGR 5010 L** 5.0 Implant Drill - Ø 4.3 mm - Long 10 mm
- FGR 5011 L** 5.0 Implant Drill - Ø 4.3 mm - Long 11,5 mm
- FGR 5013 L** 5.0 Implant Drill - Ø 4.3 mm - Long 13 mm



- FGR 3408 S** 3.4 Implant Drill - Ø 2.9 mm - Long 8,5 mm
- FGR 3410 S** 3.4 Implant Drill - Ø 2.9 mm - Long 10 mm
- FGR 3411 S** 3.4 Implant Drill - Ø 2.9 mm - Long 11,5 mm
- FGR 3413 S** 3.4 Implant Drill - Ø 2.9 mm - Long 13 mm
- FGR 3415 S** 3.4 Implant Drill - Ø 2.9 mm - Long 15 mm

Small Drive



- IP4MG 4S** Mouter Guidata - Internal Hex ● Small Drive
- IP4MG 4L** Mouter Guidata - Internal Hex ● Large Drive



- FGR 3408 L** 3.4 Implant Drill - Ø 2.9 mm - Long 8,5 mm
- FGR 3410 L** 3.4 Implant Drill - Ø 2.9 mm - Long 10 mm
- FGR 3411 L** 3.4 Implant Drill - Ø 2.9 mm - Long 11,5 mm
- FGR 3413 L** 3.4 Implant Drill - Ø 2.9 mm - Long 13 mm
- FGR 3415 L** 3.4 Implant Drill - Ø 2.9 mm - Long 15 mm

Large Drive



- SP3MG 3S** Mouter Guidata - External Hex ● Small Drive
- SP4MG 4L** Mouter Guidata - External Hex ● Large Drive
- SP4MG 4S** Mouter Guidata - External Hex ● Small Drive



- FGR 3808 S** 3.8 Implant Drill - Ø 3.3 mm - Long 8,5 mm
- FGR 3810 S** 3.8 Implant Drill - Ø 3.3 mm - Long 10 mm
- FGR 3811 S** 3.8 Implant Drill - Ø 3.3 mm - Long 11,5 mm
- FGR 3813 S** 3.8 Implant Drill - Ø 3.3 mm - Long 13 mm
- FGR 3815 S** 3.8 Implant Drill - Ø 3.3 mm - Long 15 mm

Large Drive



- IP3MG 3L-P** Mouter Guidata - Platinum CC ● Large Drive
- IP3MG 3S-P** Mouter Guidata - Platinum CC ● Small Drive
- IP4MG 4L-P** Mouter Guidata - Platinum CC ● Large Drive



- FGR 3808 L** 3.8 Implant Drill - Ø 3.3 mm - Long 8,5 mm
- FGR 3810 L** 3.8 Implant Drill - Ø 3.3 mm - Long 10 mm
- FGR 3811 L** 3.8 Implant Drill - Ø 3.3 mm - Long 11,5 mm
- FGR 3813 L** 3.8 Implant Drill - Ø 3.3 mm - Long 13 mm
- FGR 3815 L** 3.8 Implant Drill - Ø 3.3 mm - Long 15 mm



- FGR 4208 S** 4.2 Implant Drill - Ø 3.6 mm - Long 8,5 mm
- FGR 4210 S** 4.2 Implant Drill - Ø 3.6 mm - Long 10 mm
- FGR 4211 S** 4.2 Implant Drill - Ø 3.6 mm - Long 11,5 mm
- FGR 4213 S** 4.2 Implant Drill - Ø 3.6 mm - Long 13 mm
- FGR 4215 S** 4.2 Implant Drill - Ø 3.6 mm - Long 15 mm



- FGR 4208 L** 4.2 Implant Drill - Ø 3.6 mm - Long 8,5 mm
- FGR 4210 L** 4.2 Implant Drill - Ø 3.6 mm - Long 10 mm
- FGR 4211 L** 4.2 Implant Drill - Ø 3.6 mm - Long 11,5 mm
- FGR 4213 L** 4.2 Implant Drill - Ø 3.6 mm - Long 13 mm
- FGR 4215 L** 4.2 Implant Drill - Ø 3.6 mm - Long 15 mm

Bibliography

Enhanced Extracellular Matrix Deposition on Titanium Implant Surfaces: Cellular and Molecular Evidence

Guya Diletta Marconi, Luigia Fonticoli, Ylenia Della Rocca, Stefano Oliva, Thangavelu Soundara Rajan, Oriana Trubiani, Giovanna Murmura, Francesca Diomedea,* and Jacopo Pizzicannella

Biomedicines Journal, Published: 18 November 2021

The Bacterial Anti-Adhesive Activity of Double-Etched Titanium (DAE) as a Dental Implant Surface

Morena Petrini, Alessandra Giuliani, Emanuela Di Campi, Silvia Di Lodovico, Giovanna Iezzi, Adriano Piattelli, and Simonetta D'Ercole

International Journal of Molecular Sciences, Published: 5 November 2020

The Influence of the Implant Macro Geometry on Insertion Torque, Removal Torque, and Periotest Implant Primary Stability: A Mechanical Simulation on High-density Artificial Bone

Margherita Tumedei, Morena Petrini, Davide Pietropaoli, Alessandro Cipollina, Castrenze La Torre, Maria Stella Di Carmine, Adriano Piattelli, and Giovanna Iezzi

Symmetry Journal, Published: 30 April 2021

Fixture Length and Primary Stability: An In Vitro Study on Polyurethane Foam

Morena Petrini, Margherita Tumedei, Alessandro Cipollina, Simonetta D'Ercole, Maria Stella Di Carmine, Adriano Piattelli, Marco Re, and Giovanna Iezzi

Applied Sciences Journal, Published: 4 March 2022

VEGF/VEGF-R/RUNX2 Upregulation in Human Periodontal Ligament Stem Cells Seeded on Dual Acid Etched Titanium Disk

Francesca Diomedea, Guya Diletta Marconi, Marcos F. X. B. Cavalcanti, Jacopo Pizzicannella, Sante Donato Pierdomenico, Luigia Fonticoli, Adriano Piattelli and Oriana Trubiani

Materials journal, published: 5 February 2020

Horizontal Ridge Augmentation with the Cortical Lamina Technique: A Case Report

Roberto Rossi, Alessandro Conti, Davide Bertazzo, and Andrea PILLONI*

Modern research in dentistry, published: November 12, 2019

Effect of bioactivation on traditional surfaces and Zirconium Nitride: adhesion and proliferation of preosteoblastic cells and bacteria

Roberto Pistilli, Tullio Genova, Luigi Canullo, Maria Giulia Faga, Maria Elena Terlizzi, Giorgio Gribaud, Federico Mussano

AperTO journal, published: 22 November 2023

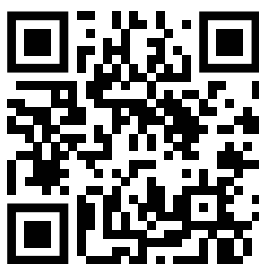

www.resista.it

Resista view

Resista website:

Resista Group's website is available to everyone for more communication with you.



Resista TV:

In order to cover the activities of Resista group as much as possible, Resista TV has been launched and things like specialized webinars are available to our audience through this media.



Resista academy:

Resista Academy is one of the active departments in Resista Group. In order to strengthen the educational aspect of Resista, Resista Group has formed an academy to provide dentists with the opportunity to learn in different areas of dentistry.



Resista social media:

For more and better communication with the dental community, as well as information about new products and services of Resista Group, it is necessary to be present on social networks. For this reason, Resista Group is present in all social networks and is looking for you as much as possible.



Resista patient brochure:

In order to communicate with the people who are the end users of dental implants, Resista seeks to accompany and educate people about oral and dental health by producing specialized content.



EXCELLENT TRAINING

RESISTA Academy

Register and participate in our Video Courses and Webinars, individually and for as long as you want.



RESISTA ACADEMY



RESISTA
ACADEMY

Semplicità ed efficacia nella diagnosi e nel trattamento con terapia fotodinamica

GTR AND SOFT TISSUES
Simplicity and effectiveness in the diagnosis and treatment of periodontal disease with photodynamic therapy



RESISTA
ACADEMY

L'amministrazione dello studio dentistico: Quali gli errori da evitare

LEGAL ASPECTS OF THE DENTAL PRACTICE
The administration of the dental practice: what mistakes to avoid



RESISTA
ACADEMY

Lo stato dell'arte in chirurgia guidata

GUIDED SURGERY AND DYNAMIC SURGERY
The state of the art in guided surgery. The importance of changing our habits between digitalisation and ethical implantology



RESISTA
ACADEMY

La colla chirurgica: la rivoluzione in una goccia

REGENERATIVE
Surgical kit: the revolution in a drop



RESISTA
ACADEMY

Le lesioni bianche dello smalto

CONSERVATIVE AND PROSTHESIS
White enamel lesions: minimally invasive diagnosis and treatment procedures in the aesthetic area



RESISTA
ACADEMY

Il paziente odontofobico: affrontare e gestire le loro e le nostre paure

MARKETING AND COMMUNICATION WITH THE PATIENT
The dental phobic patient: facing and managing their and our fears

BRAND	CATEGORY	NAME/CODE	DESCRIPTION
DENTICSH	Abutment	DIRC-C451570	Straight Abutment H7,GH1.5
DENTICSH	Abutment	DIRC-C452570	Straight Abutment H7,GH 2.5
DENTICSH	Abutment	DIRC-C453570	Straight Abutment H7,GH 3.5
DENTICSH	Abutment	DIRC-A451515	Angled Abutment Φ 4.5, GH1.5, 15°
DENTICSH	Abutment	DIRC-A451525	Angled Abutment Φ 4.5, GH2.5, 15°
DENTICSH	Abutment	DIRC-A451535	Angled Abutment Φ 4.5, GH3.5, 15°
DENTICSH	Abutment	DIRC-A452515	Angled Abutment Φ 4.5, GH1.5, 25°
DENTICSH	Abutment	DIRC-A452525	Angled Abutment Φ 4.5, GH2.5, 25°
DENTICSH	Abutment	DIRC-A452535	Angled Abutment Φ 4.5, GH3.5, 25°
DENTICSH	Premill	DIRC-PA	Premill RC abutment/ D10
DENTICSH	Scan Body	DIRC-SA	Scan RC abutment
DENTICSH	Sleeve	DIRC-TS41	Sleeve Φ 4
DENTICSH	Sleeve	DIRC-TS55	Sleeve Φ 5.5
UNIQUE	Healing	UIRC-HA4020	Healing Abutment Φ 4 GH2mm
UNIQUE	Healing	UIRC-HA4030	Healing Abutment Φ 4 GH3mm
UNIQUE	Healing	UIRC-HA4040	Healing Abutment Φ 4 GH4mm
UNIQUE	Healing	UIRC-HA4060	Healing Abutment Φ 4 GH6mm
UNIQUE	Healing	UIRC-HA5030	Healing Abutment Φ 5 GH3mm
UNIQUE	Healing	UIRC-HA5040	Healing Abutment Φ 5 GH4mm
UNIQUE	Healing	UIRC-HA5050	Healing Abutment Φ 5 GH5mm
UNIQUE	Healing	UIRC-HA5060	Healing Abutment Φ 5 GH6mm
UNIQUE	Healing	UIRC-HA6030	Healing Abutment Φ 6 GH3mm
UNIQUE	Healing	UIRC-HA6040	Healing Abutment Φ 6 GH4mm
UNIQUE	Imperssion	UIRC-IC040S	Imperssion Coping Open Short
UNIQUE	Imperssion	UIRC-IC040L	Imperssion Coping Open long
UNIQUE	Analog	UIRC-LA4	Lab Analog

BRAND	CATEGORY	NAME/CODE	DESCRIPTION
RESISTA	Cortical Drill	FIS35	\varnothing 2mm
RESISTA	Cortical Drill	FIS40	\varnothing 2mm
RESISTA	Cortical Drill	FIS50	\varnothing 2mm
RESISTA	Cylindrical Drill	FC520	\varnothing 2.0mm, L 18mm
RESISTA	Tapered Drill	FKS30	\varnothing 3.0mm, L 18mm
RESISTA	Tapered Drill	FKS34	\varnothing 3.4mm, L 18mm
RESISTA	Tapered Drill	FKS38	\varnothing 3.8mm, L 18mm
RESISTA	Tapered Drill	FKS42	\varnothing 4.2mm, L 18mm
RESISTA	Tapered Drill	FKS46	\varnothing 4.6mm, L 18mm
RESISTA	Tapered Drill	FKS50	\varnothing 5.0mm, L 18mm
RESISTA	Paralleling Pin	Paralleling Pin	S 1.8mm / L 3mm
RESISTA	Manual Screw Driver	DM01	Hexagonal 1.27 - Short 12mm
RESISTA	Manual Screw Driver	DM02	Hexagonal 1.27 - Medium 17mm
RESISTA	Manual Screw Driver	DM03	Hexagonal 1.27 - Long 27mm
RESISTA	Ratchet Screw Driver	W2-DCC01	Hexagonal 1.27 - Short 15mm
RESISTA	Ratchet Screw Driver	W2-DCC02	Hexagonal 1.27 - Medium 20mm
RESISTA	Ratchet Screw Driver	W2-DCC03	Hexagonal 1.27 - Long 30mm
RESISTA	Angle Screw Driver	W2-DC01	Hexagonal 1.27 - Short 15mm
RESISTA	Angle Screw Driver	W2-DC02	Hexagonal 1.27 - Medium 20mm
RESISTA	Angle Screw Driver	W2-DC03	Hexagonal 1.27 - Long 30mm
RESISTA	Ratchet Fixture Driver	PC01R	Short
RESISTA	Ratchet Fixture Driver	PC02R	Medium
RESISTA	Ratchet Fixture Driver	PC03R	Long
RESISTA	Manual Fixture driver	DGM	-
RESISTA	Angle Fixture Driver	W2-AC01	Short
RESISTA	Angle Fixture Driver	W2-AC02	Long
RESISTA	Drill Stopper	ST7	7 mm
RESISTA	Drill Stopper	ST8	8.5 mm
RESISTA	Drill Stopper	ST10	10 mm
RESISTA	Drill Stopper	ST11	11mm
RESISTA	Drill Stopper	ST13	13mm
RESISTA	Ratchet	CRND	No Torque
RESISTA	Ratchet	CRD2	Torque
RESISTA	Socket of Ratchet	CRD2-G	Ratchet Socket
RESISTA	Depth Gauge	SOM	Titanium Surgical Probe
DENTISCH	Drill Extension	DIRC-DE	Compatible wit Resista
DENTISCH	Manual Screw Driver	DIRC-DRI127L22	Compatible with Resista & Symphony
DENTISCH	Manual Screw Driver	DIRC-DRI127S16	Compatible with Resista & Symphony
DENTISCH	Point with Drill	DL-Point Drill	Compatible with Resista & Symphony
UNIQUE	Manual Screw Driver	UIRC-DM02-L20	Compatible with Resista & Symphony

BRAND	CATEGORY	NAME/CODE	DESCRIPTION
RESISTA	FIXTURE	IK3407	Φ 3.4, L7
RESISTA	FIXTURE	IK3408	Φ 3.4, L8.5
RESISTA	FIXTURE	IK3410	Φ 3.4, L10
RESISTA	FIXTURE	IK3411.5	Φ 3.4, L11.5
RESISTA	FIXTURE	IK3413	Φ 3.4, L13
RESISTA	FIXTURE	IK3807	Φ 3.8, L7
RESISTA	FIXTURE	IK3808	Φ 3.8, L8.5
RESISTA	FIXTURE	IK3810	Φ 3.8, L10
RESISTA	FIXTURE	IK3811	Φ 3.8, L11.5
RESISTA	FIXTURE	IK3813	Φ 3.8, L13
RESISTA	FIXTURE	IK4207	Φ 4.2, L7
RESISTA	FIXTURE	IK4208	Φ 4.2, L8.5
RESISTA	FIXTURE	IK4210	Φ 4.2, L10
RESISTA	FIXTURE	IK4211	Φ 4.2, L11.5
RESISTA	FIXTURE	IK4213	Φ 4.2, L13
RESISTA	FIXTURE	IK4607	Φ 4.6, L7
RESISTA	FIXTURE	IK4608	Φ 4.6, L8.5
RESISTA	FIXTURE	IK4610	Φ 4.6, L10
RESISTA	FIXTURE	IK4611	Φ 4.6, L11.5
RESISTA	FIXTURE	IK4613	Φ 4.6, L13
RESISTA	FIXTURE	IK5007	Φ 5, L7
RESISTA	FIXTURE	IK5008	Φ 5, L8.5
RESISTA	FIXTURE	IK5010	Φ 5, L10
RESISTA	FIXTURE	IK5011	Φ 5, L11.5
RESISTA	FIXTURE	IK5013	Φ 4.2, L13
RESISTA	HEALING	IP4HA2-W	Φ 4.0, H 2, CPS
RESISTA	HEALING	IP4HA4-W	Φ 4.0, H 4, CPS
RESISTA	HEALING	IP4HA6-W	Φ 4.0, H 6, CPS
RESISTA	HEALING	IP4HA2-W	Φ 4.0, H 2
RESISTA	COVER SCREW	IP4CS1	1.5 MM
RESISTA	COVER SCREW	IP4CS1	3.0 MM
RESISTA	COVER SCREW	IP4CS1	5.0 MM
RESISTA	CASTABLE ABUTMENT	IP4CA-W	ANTIROTATION HEX, FULL PLASTIC
RESISTA	CASTABLE ABUTMENT	IP4CR-W	ROTATING, FULL PLASTIC
RESISTA	UCLA / CoCr	IP4CCA-W	ANTIROTATION HEX
RESISTA	UCLA / CoCr	IP4CCR-W	ROTATING
RESISTA	Temporery Abutment	IP4TA-W	ANTIROTATION HEX
RESISTA	Temporery Abutment	IP4TR-W	ROTATING
RESISTA	STRAIGHT ABUTMENT	IP4ST2-W	
RESISTA	ANGLED ABUTMENT	IP4AT15-W	15°
RESISTA	ANGLED ABUTMENT	IP4AT25-W	25°
RESISTA	SCAN ABUTEMENT	AP4SA2DS	ANTIROTATION
RESISTA	SCAN ABUTEMENT	IP 4SA2DS	φ 4
RESISTA	LAB ANALOG	IP4AL2DS-V	H12, WITH SCREW
RESISTA	Ti Base ABUTMENT	IP4TB0DS-W	ANTIROTATION HEX, H 0.3
RESISTA	Ti Base ABUTMENT	IP4TBR0DS-W	ROTATING, H 0.3
RESISTA	Ti Base ABUTMENT	IP4TB1DS-W	ANTIROTATION HEX, H 1.5
RESISTA	Ti Base ABUTMENT	IP4TBR1DS-W	ROTATING, H 1.5
RESISTA	Ti Base ABUTMENT	IP4TB2DS-W	ANTIROTATION HEX, H 2.5
RESISTA	Ti Base ABUTMENT	IP4TBR2DS-W	ROTATING, H 2.5
RESISTA	Imperssion Open	IP X40-W	φ 4
RESISTA	Fixture Mount	IPM40	IMPERSSION CLOSE
RESISTA	Analog	IP 4AL	φ 4



Ing. Carlo Alberto Issoglio & C. S.r.l.

Via F.lli Di Dio, 68 - 28887 Omegna (VB) - ITALIA

Tel. +39 0323.828.004

www.resista.it

www.noyandental.com info@noyandental.com

Tel: 021-88033237

Whatsapp: 09108112896